



FluxSense



Does your industry emit gas? From where and how much?
It is worth investing in better technology?

01. Company Introduction



FluxSense AB (Org. no. 556613-8730) is a company from Gothenburg Sweden. It provides measurements services and Instrument products for optical remote sensing of gaseous emissions. The company was founded in 2001 and is incorporated and organized under the laws of Sweden.

FluxSense has developed four techniques for gas emission measurements (**SOF, MeFTIR, MeDOAS and SkyDOAS**). These systems are built in to a mobile laboratory for real-time gas emission measurements and leak search. A special focus is on measuring diffuse emissions of Volatile Organic Compounds (VOCs).

As a service provider, FluxSense has carried out more than 100 industrial surveys in Europe, the US, Canada and Asia working both for authorities and industrial partners. FluxSense is sole provide for the **Solar Occultation Flux technique (SOF)** and this method is today Best Available Technology (BAT) in Europe for measurements of diffuse emission of VOCs and other species from refineries and petrochemical industry and it is being standardized within the European Union, CEN (TC 264 WG 38).

FluxSense is sole provide for the Solar Occultation Flux technique (SOF) and this method is today Best Available Technology (BAT) in Europe for measurements of diffuse emission of VOCs and other species from refineries and petrochemical industry and it is being standardized within the European Union, CEN (TC 264 WG 38).



02. Product Overview

Method	SOF	SkyDOAS	MeFTIR	MeDOAS
Compounds	Total alkane, carbon-number alkane, NH ₃ , CO	NO ₂ SO ₂ HCHO	Alkane, CH ₄ , C ₂ H ₄ , C ₃ H ₆ , NH ₃ , CO, CO ₂ , N ₂ O	BTEX SO ₂
Principle	Open path, slant atmospheric column	Open path, Zenith atmospheric column	Extractive multireflection cell	Open path multi-reflection cell
Measured unit	Vertical path integrated concentration	Vertical path integrated concentration	Concentration	Concentration
Sensitivity	0.1 - 5 mg/m ²	0.1 - 5 mg/m ²	1 - 10 ppb	0.2 - 3 ppb
Flux limit	0.2 - 1 kg/h	1 kg/h	0.2 - 2 kg/h	0.15 - 0.25 kg/h
Wind Speed	1.5 = 12 m/s	1.5 = 12 m/s	1 = 12 m/s	1 = 12 m/s
Time response	1 - 5 sec	1 - 5 sec	5 - 15 sec	5 - 15 sec

03. Detail Description

1) SOF (Solar Occultation Flux System)



The Solar Occultation Flux system is suitable for measurements of alkane, ethylene and propylene gas emissions from industrial sites. Other gas species can be requested. This system includes hardware and analysis software and initial instrument training.

In addition, the system includes some auxiliary equipment. The system should be operated from a measurement van equipped with a sun roof which is provided by the customer.

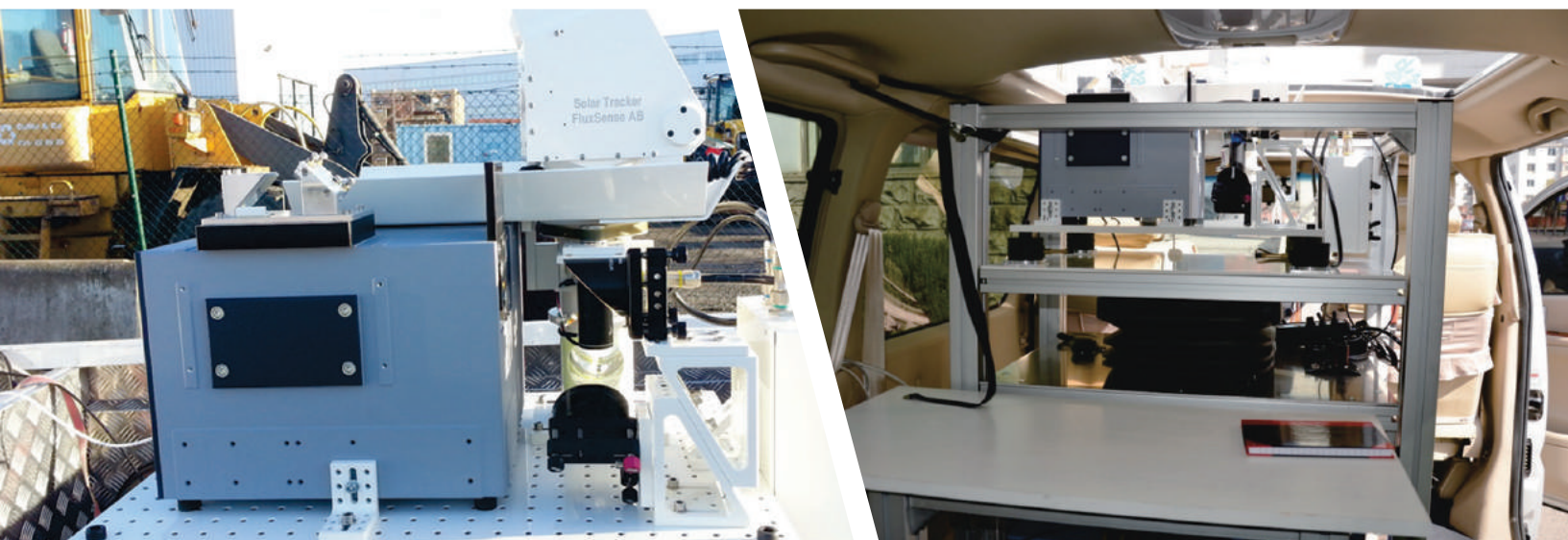

Advice

- *A yearly measurement can be used as a basis to decide whether investments in abatement technology is cost effective.*
- *A gas leak is a potential safety danger.*
- *Measurements promote good public relations.*



In the Solar Occultation Flux method (SOF) gases are measured by observing solar light in the infrared portion of the solar spectrum

03. Detail Description

2) SKYDOAS

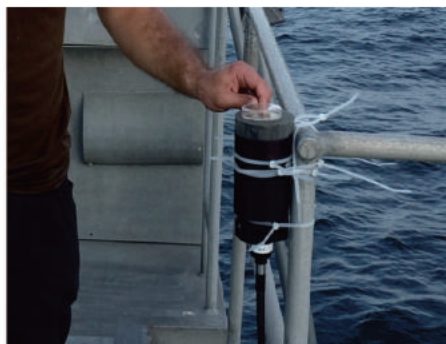

Skydoas, Spectrometer and telescope

The system is based on a **temperature stabilized grating spectrometer** with CCD camera. The spectrometer will be preconfigured for measurements in the 300-360 nm wavelength window.

The spectrometer will be mounted in a temperature-stabilized enclosure and connected to a zenith-viewing telescope by means of an optical multimode fiber. The temperature-stabilized enclosure will be supplied with an electronic control system and the telescope will be equipped with a shutter and a calibration light source to facilitate easy calibrations.

System Information

System	Dimensions	Weight	Operational environmental conditions		
			Temp	Humidity	Dust and water protection grade
SKYDOAS	20 cm*20cm *20 cm	5 kg	0-50°C	0-90%	Splash proof housing

3) MeFTIR

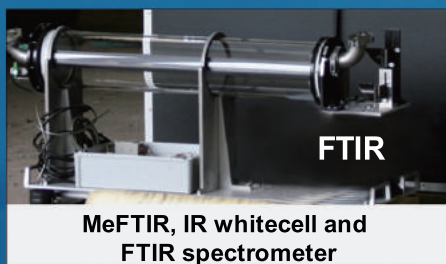

The system is based on a **FTIR spectrometer** with a high resolution scanner upgrade (to 0.5 cm⁻¹). The spectrometer will be equipped with **Ge-windows** and **beam splitter (non-hygroscopic)** to be able to operate in outside air conditions.

The spectrometer will be equipped with a liquid nitrogen (LN2) cooled sandwich detector (MCT + InSb) for alkenes and alkanes.

MeFTIR

The **FTIR spectrometer** will be connected to a multi-pass optical gas cell with long path-length and high reflectance coating (custom made, approx. 100m). The spectrometer and optical cell is connected by custom aligned transfer optics, and mounted on a vibration dampening platform for deployment in a mobile van. Temperature and pressure in the measurement cell will be measured and logged. The long path-length cell and stabilized system grant very good detection limits at ppb levels.

The system comes with a laptop control computer with installed software to operate the system, to view spectra, to get real time data and to carry out post analysis (MeFTIR-measure and MeFTIR-Report).

System Information

System	Dimensions	Weight	Operational environmental conditions		
			Temp	Humidity	Dust and water protection grade
MeFTIR	140 cm*50cm *60 cm	100 kg	5-35°C	0-90%	Splash proof housing

03. Detail Description

4) MeDOAS



The system is based on an **temperature stabilized fixed grating spectrometer** with a high sensitivity CCD camera.

The spectrometer will be connected to a **multi-pass optical gas cell** with **long path-length** and **high reflectance coating** (FluxSense custom make, approx. 100 m). Light into the cell is provided by a Xenon arc lamp connected to the cell by fiber/Transfer optics. Light from both the cell and the calibrating lamp is brought into the spectrometer via a bifurcated fiber bundle arranged to optimize the light through the spectrometer slit.

Spectrometer and optical cell are mounted on a vibration dampening platform for deployment in a mobile van. The MeDOAS system will be thermo-stated for **optimal performance** and **stability**. The long path-length cell and stabilized system grant good detection limits at ppb levels.

The system is controlled by a computer with installed software to operate the system, to view spectra, to get real time data and to carry out post analysis (DOAS-measure and DOAS-Report). This computer also controls other measurement instruments.



The DOAS enclosure and optical gas cell enclosures

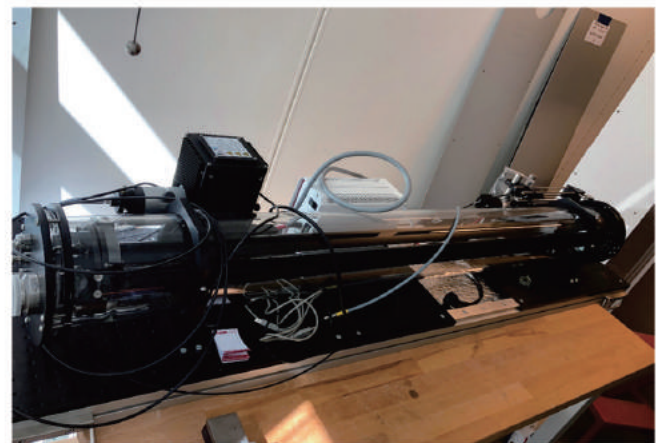

Andor spectrometer and UV optical gas cell

System Information

System	Dimensions	Weight	Operational environmental conditions		
			Temp	Humidity	Dust and water protection grade
MeDOAS	200 cm*50cm*60 cm	90 kg	5-35°C	0-90%	Splash proof housing

Mobile extractive DOAS System

04. Measurement

FluxSense Instrumentation (Mobile lab)

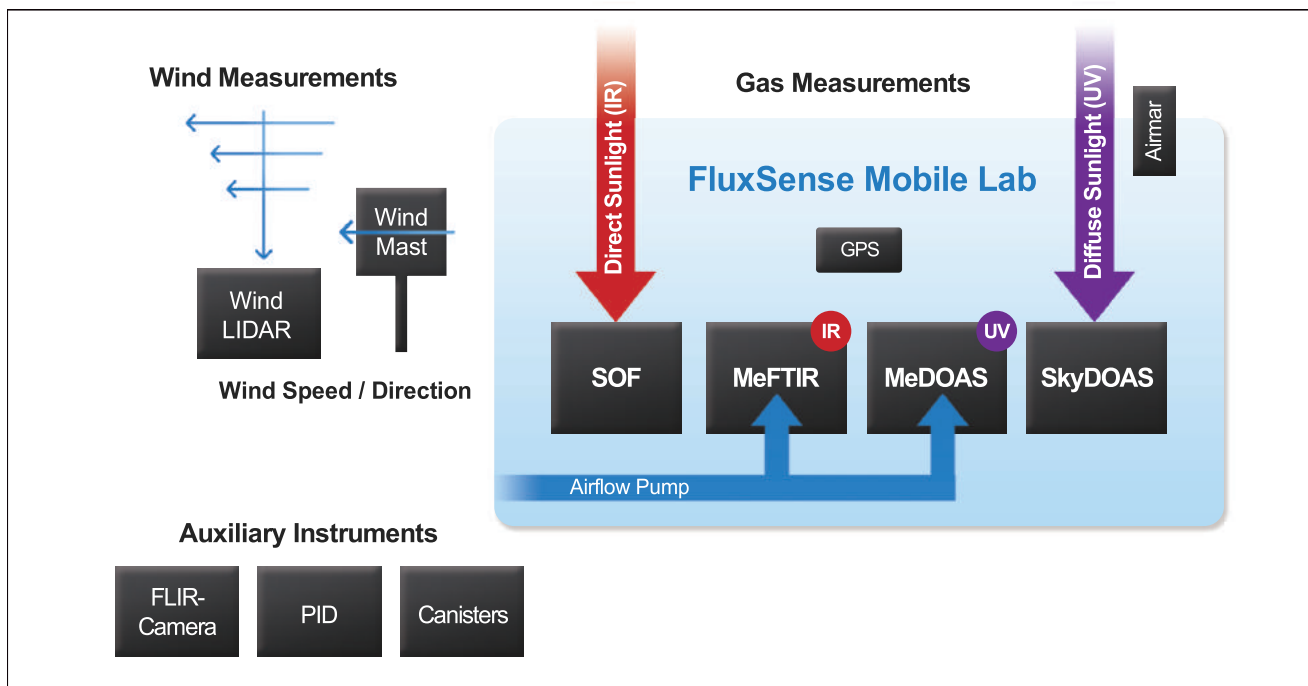

05. Data Processing and Results

1) Data Processing

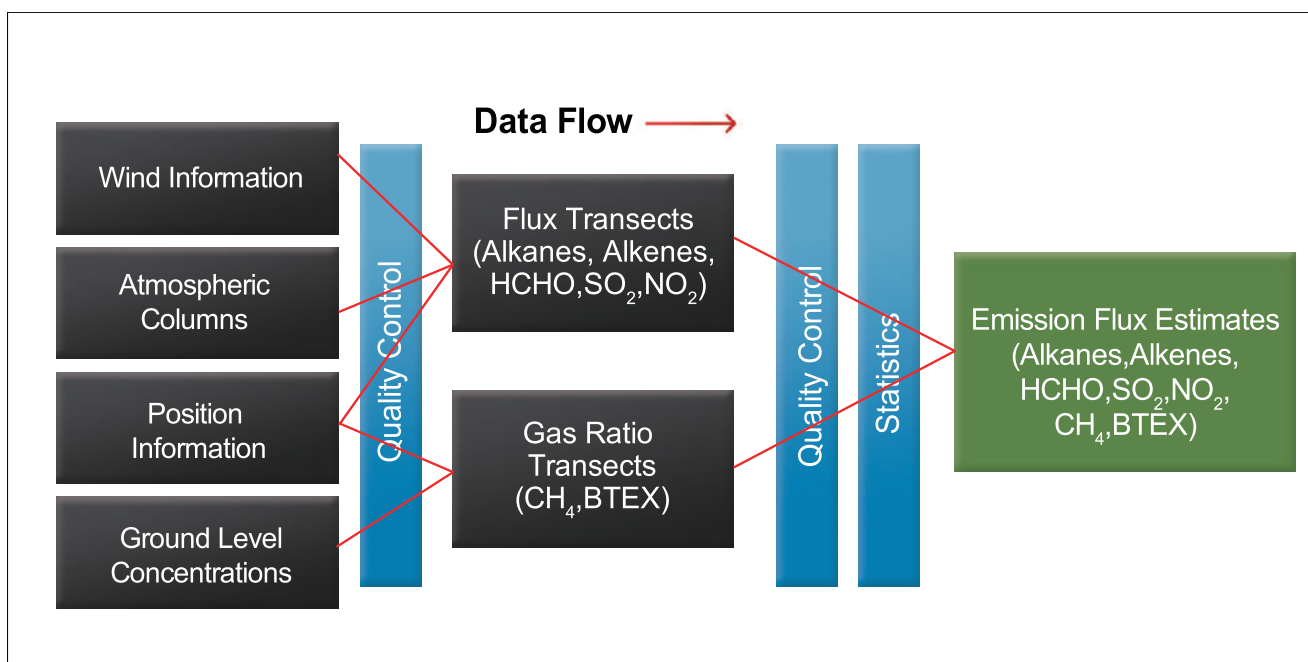

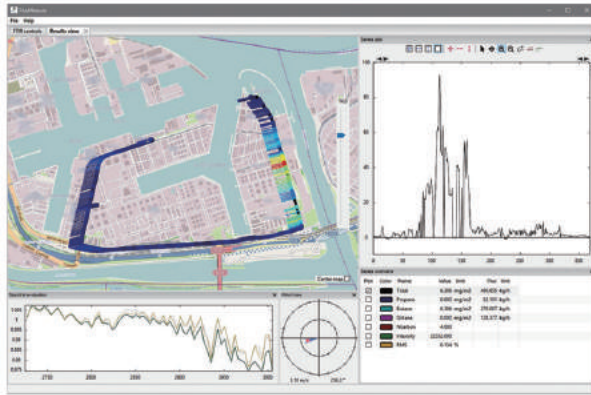

SOF MEASURE program

SOF measurements in an oil harbour. In the upper left is shown an orthographic map with the position of the measurement with lines pointing towards the sun.

The measured and fitted **absorption spectra** are shown in the lower left, and the retrieved data of alkanes on the right side.

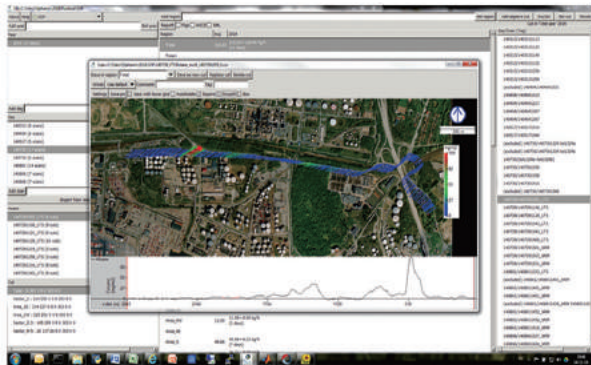

Example of SOF measurements

Example of SOF box measurements in the **"near field"** circling around leaking tanks.

Blue color represents the lowest and red the highest columns, and the lines are pointing up wind, also indicated with arrow.

SOF Standardisation/Validation

- Validation experiments at abandoned refinery in an anonymous city and demonstration measurements at a refinery in an anonymous city.
- Controlled release as part of SCAQMD study at an anonymous city football stadium and comparative measurements between SOF & DIAL at real sources.
- Controlled source release of C₂H₄ from mast in an anonymous city (NETAP/TCEQ).
- Controlled source release of NH₃ from mast in an anonymous city.
- Many other studies, showing 20-40% uncertainty

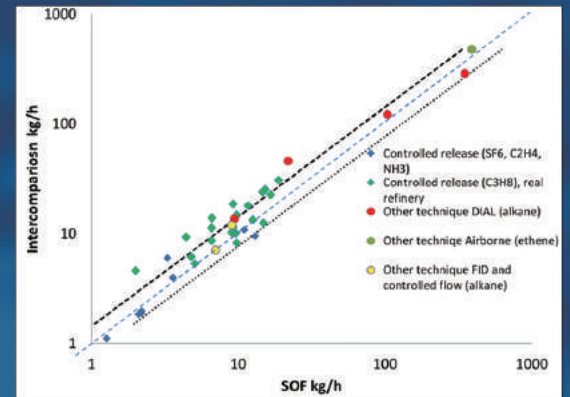

Validation studies SOF



Example of SOF box Measurements

- The SOF vehicle has circled around various emission areas.
- The aerial photos show VOC concentration data from SOF measurement in which warmer colors correspond to more gas and the lines points towards the wind, i.e. towards potential sources.

FluxSense

www.fluxsense.se

Head office Europe / Global:

FluxSense AB

Sven Hultins gata 9
Chalmers Teknikpark
SE-412 88 Gothenburg
SWEDEN

T. + 46 70 30 99 669

www.fluxsense.se

Exclusive distributor South Korea:

BK Instruments Inc.

BKI Bldg., 281-25,
Munji-Ro, Yuseong-Gu,
Daejeon, 34050,
Republic of KOREA

T. + 82 42 487 8240

www.bkinstruments.co.kr

USA / Canada:

FluxSense Inc.

113 W G St #757 San
Diego, CA 92101
USA